

## SPECIFICATIONS

DIAMETER:	8" (204.0 mm)
SENSITIVITY (2.83 V @ 1 m):	90 dB
POWER HANDLING:	200 W <sub>RMS</sub>
FREQUENCY RESPONSE:	35 Hz ~ 5 kHz
NOMINAL IMPEDANCE:	5 OHMS
VOICE-COIL DIAMETER:	1.5" (38.1 mm)
DIMENSIONS:	

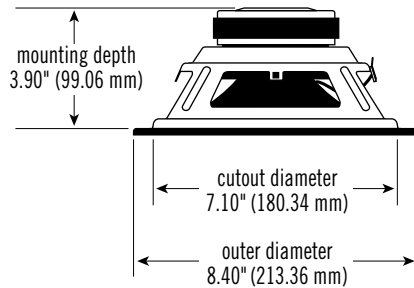

## THIELE-SMALL PARAMETERS

VOICE COIL DC RESISTANCE:	$R_{EVC}$ (OHMS) . . . . .	4.50
VOICE COIL INDUCTANCE @ 1 kHz:	$L_{EVC}$ (MH) . . . . .	0.80
DRIVER RADIATING AREA:	$S_D$ (IN <sup>2</sup> ) . . . . .	33.02
	$S_D$ (CM <sup>2</sup> ) . . . . .	214.00
MOTOR FORCE FACTOR:	$BL$ (TM) . . . . .	9.10
COMPLIANCE VOLUME:	$V_{AS}$ (FT <sup>3</sup> ) . . . . .	2.37
	$V_{AS}$ (LITERS) . . . . .	56.00
SUSPENSION COMPLIANCE:	$C_{MS}$ (µM/N) . . . . .	861.00
MOVING MASS, AIR LOAD:	$M_{MS}$ (GRAMS) . . . . .	37.50
MOVING MASS, DIAPHRAGM:	$M_{MD}$ (GRAMS) . . . . .	35.70
FREE-AIR RESONANCE:	$F_S$ (Hz) . . . . .	28.00
MECHANICAL Q:	$Q_{MS}$ . . . . .	7.60
ELECTRICAL Q:	$Q_{ES}$ . . . . .	0.36
TOTAL Q:	$Q_{TS}$ . . . . .	0.34
MAGNETIC-GAP HEIGHT:	$H_{AG}$ (IN) . . . . .	0.28
	$H_{AG}$ (MM) . . . . .	7.11
VOICE-COIL HEIGHT:	$H_{VC}$ (IN) . . . . .	0.60
	$H_{VC}$ (MM) . . . . .	15.24
MAXIMUM EXCURSION:	$X_{MAX}$ (IN) . . . . .	0.16
	$X_{MAX}$ (MM) . . . . .	4.06

## IMPEDANCE CURVE

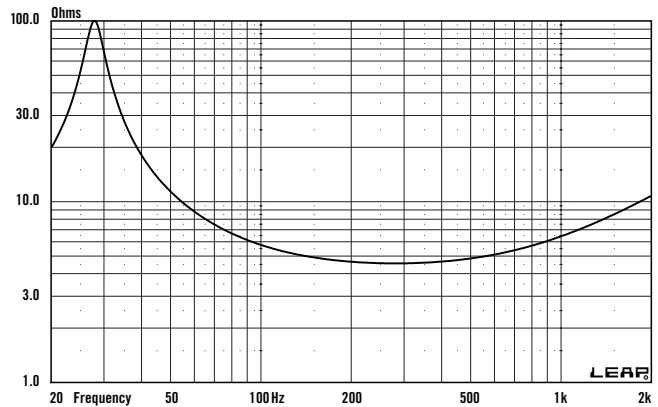

## INFINITE Baffle FREQUENCY RESPONSE @ 2.83 V

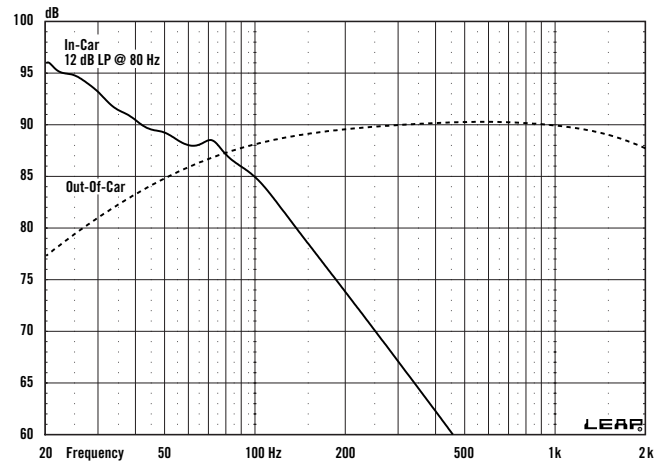

## INFINITE Baffle EXCURSION/GROUP DELAY @ 50 W

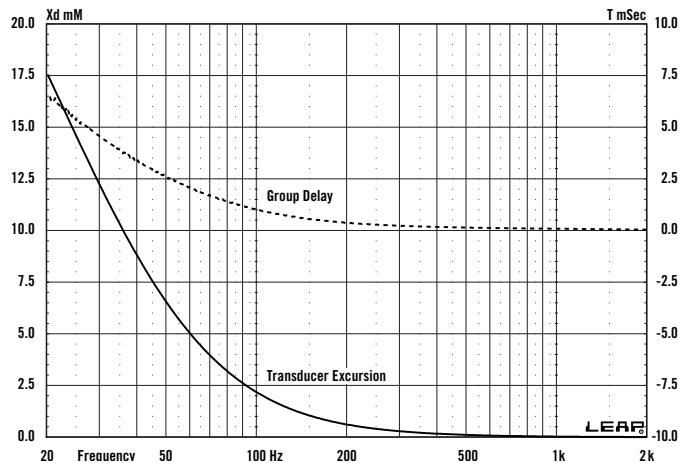



# P800 8" Woofer – Technical Data

## SEALED BOX VOLUME

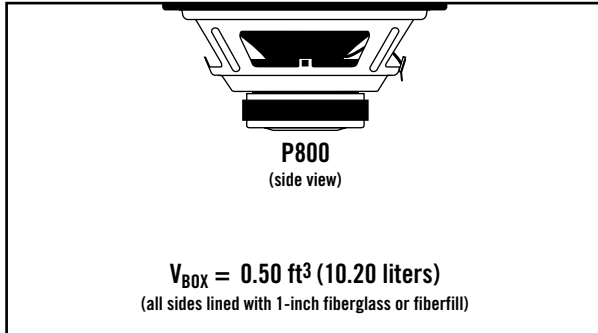

## VENTED BOX VOLUME

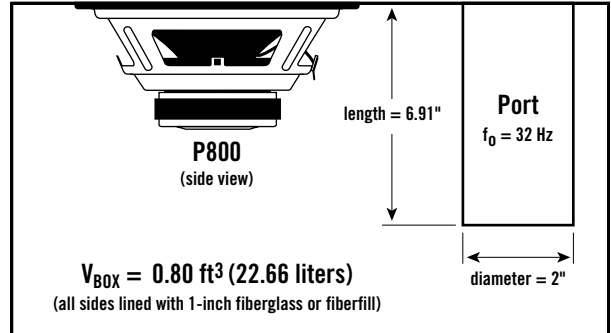

## SEALED FREQUENCY RESPONSE @ 2.83 V

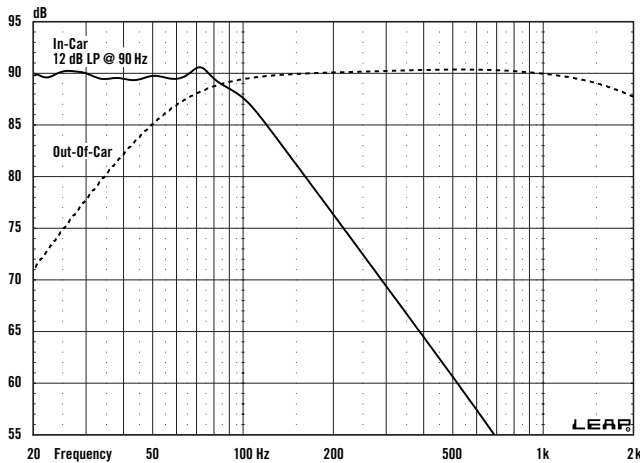

## VENTED FREQUENCY RESPONSE @ 2.83 V

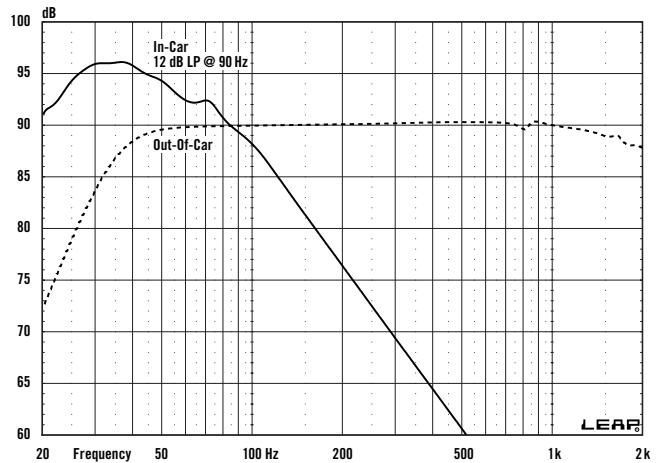

## SEALED EXCURSION/GROUP DELAY @ 100 W

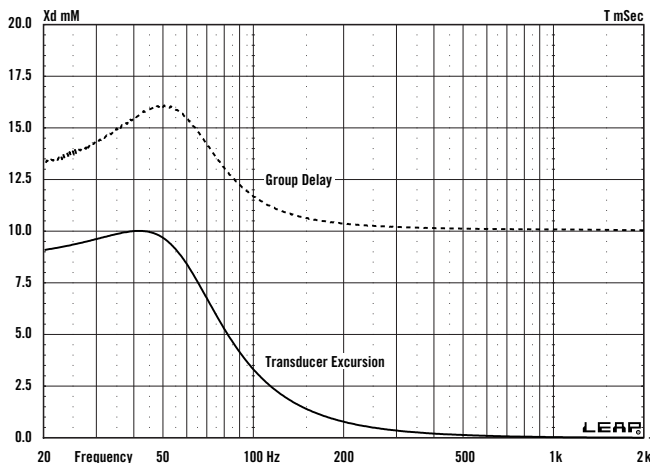

## VENTED EXCURSION/GROUP DELAY @ 100 W

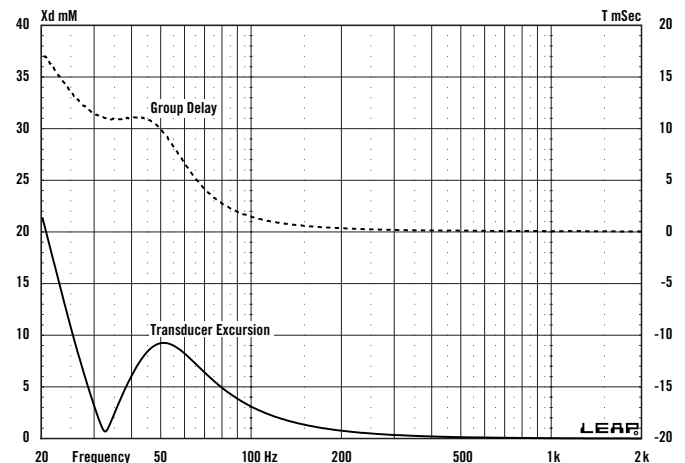

## SEALED BANDPASS BOX VOLUME

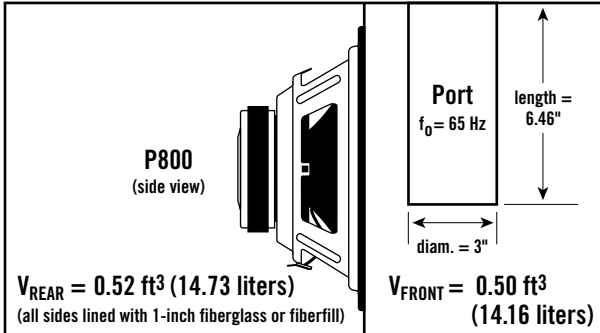

## SEALED BANDPASS FREQUENCY RESPONSE @ 2.83 V

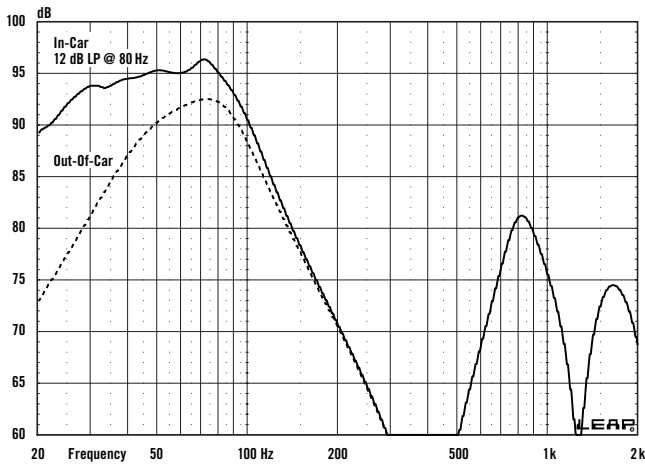

## SEALED BANDPASS EXCURSION/GROUP DELAY @ 100 W

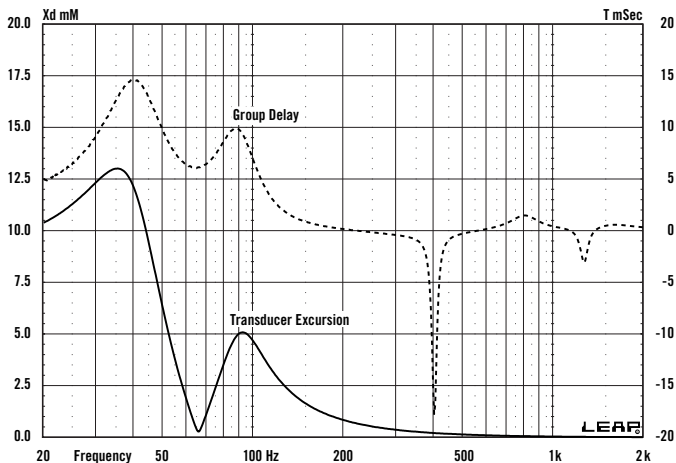

## NOTES